

THP SERIES

- ★ PADDLE ARM-EMERGENCY EXIT DEVICE.
- ★ UL LISTED PANIC HARDWARE.
- ★ 18" PADDLE FOR EASY OPERATION.

LIFE-TIME WARRANTY

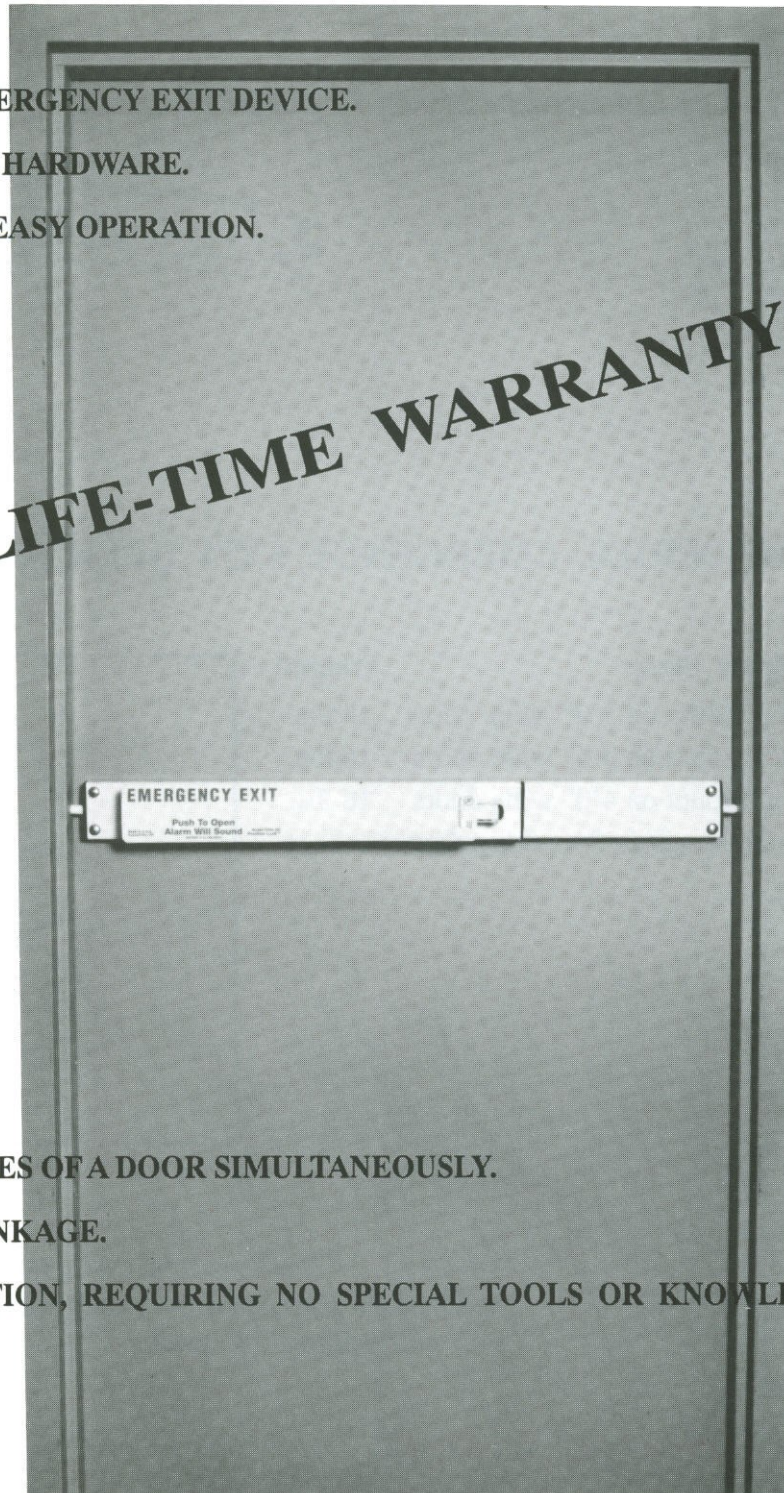

- ★ LOCKS BOTH SIDES OF A DOOR SIMULTANEOUSLY.
- ★ MECHANICAL LINKAGE.
- ★ EASY INSTALLATION, REQUIRING NO SPECIAL TOOLS OR KNOWLEDGE.

"When you absolutely, positively want to lock a door, use Positive Lock"

American Made with Quality and Pride

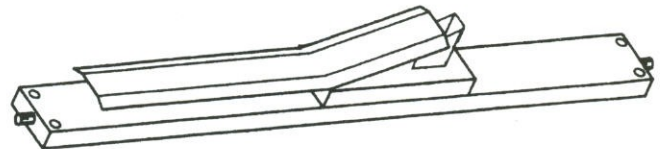
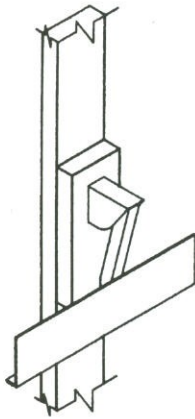
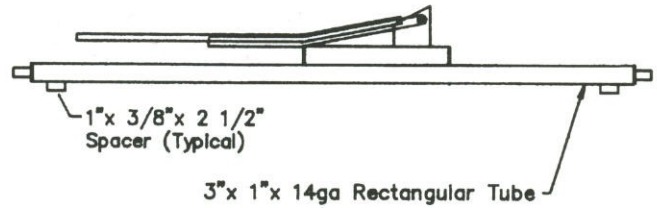
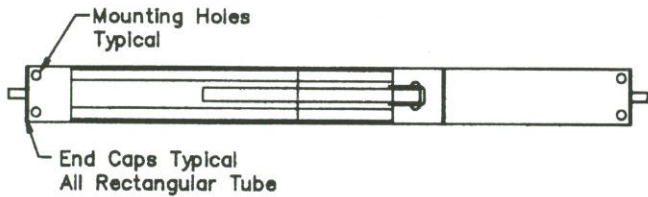

MODEL # THP-SERIES, EMERGENCY EXIT DEVICE, PADDLE ARM

Stock Sizes:

- THP-30 * For Horizontal Mount on 3'0" wide doors
- THP-36 * For Horizontal Mount on 3'6" wide doors
- THP-40 * For Horizontal Mount on 4'0" wide doors

Weight:

- 14 lbs.
- 16 lbs.
- 18 lbs.

Special sizes available within 7 working days

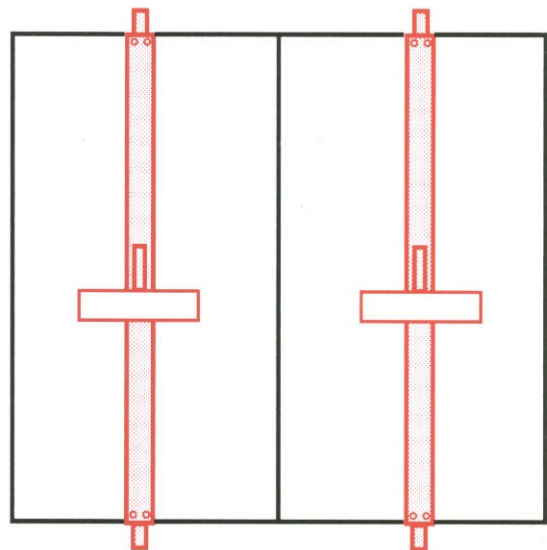
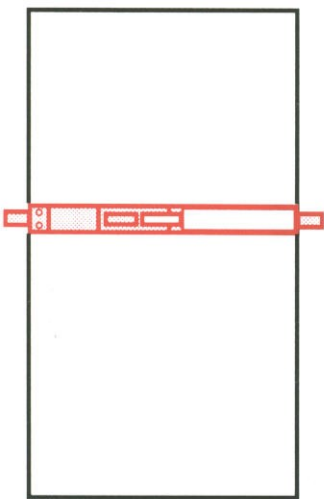

THP-70 * For Vertical Mount on 7'0" high doors
 Note: THP-70 vertical mounted locks are furnished
 with horizontal 18" paddles.

Weight:
30 lbs.

Distributed Locally by

